



...ANGLES...



By .... Kru ชี

1. Acute angle

2. Obtuse angle

3. Right angle

4. Straight angle

5. Reflex angle

6. Angle at point or angle around point

**Vertically opposite angles are equal**

Find the angles marked with letters.

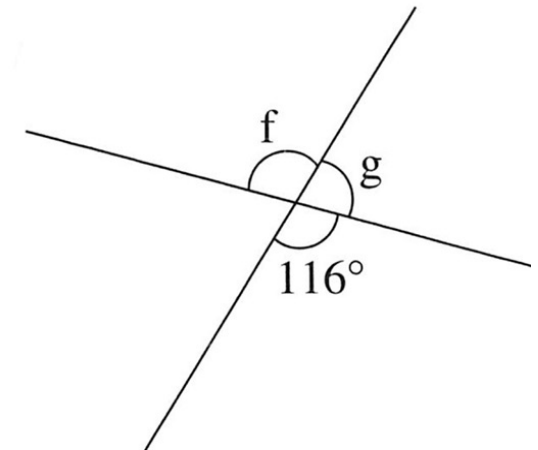
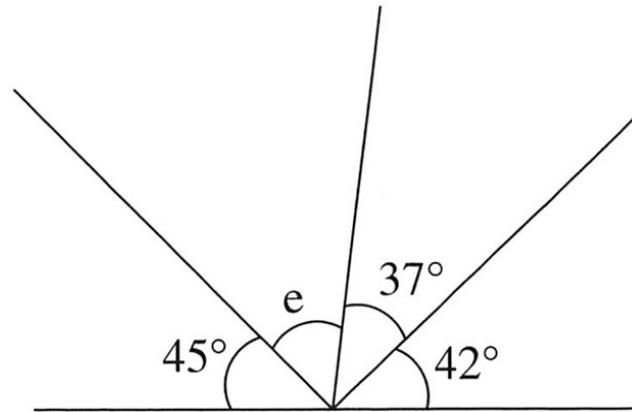
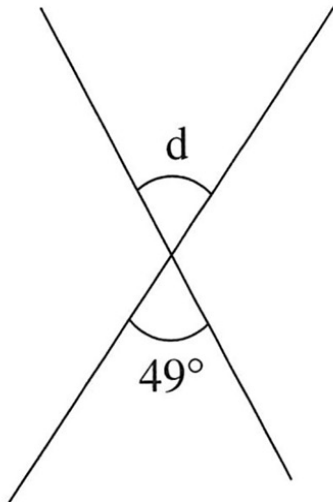
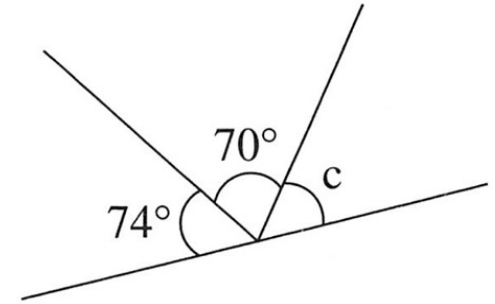
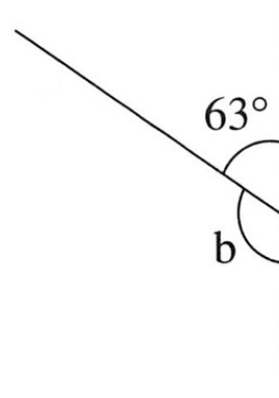
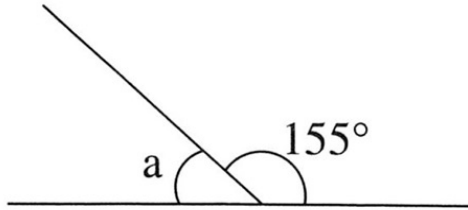

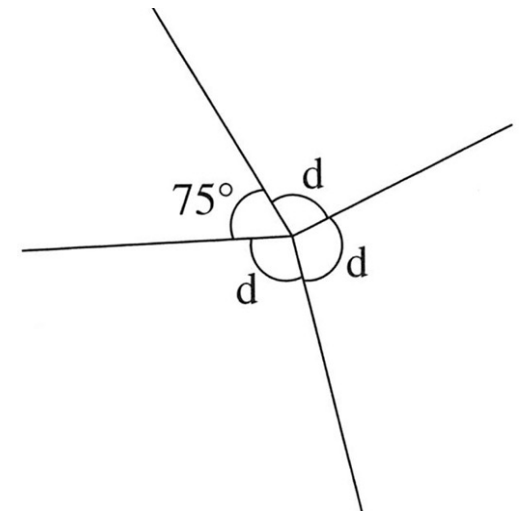
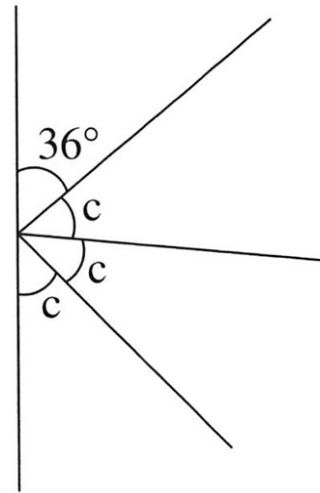
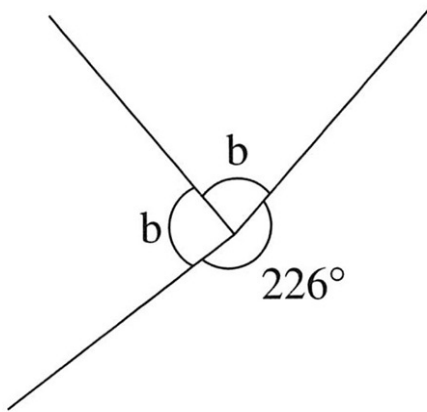
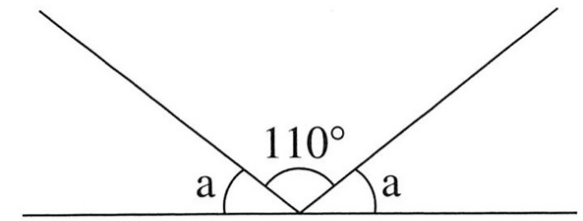
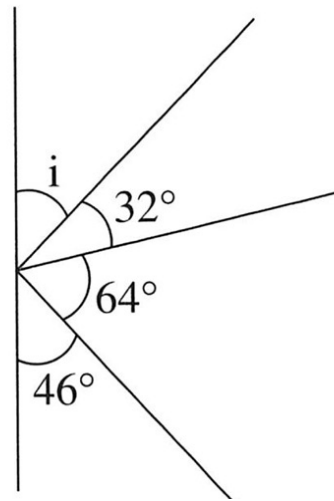
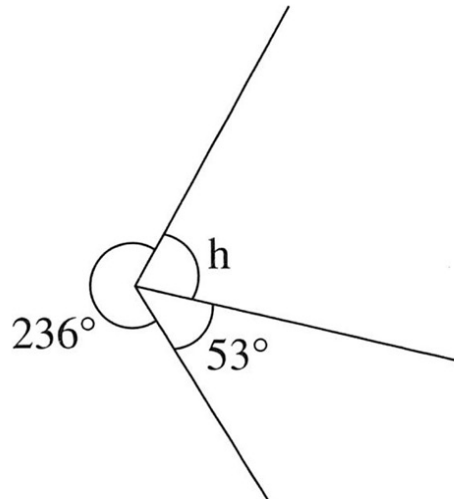

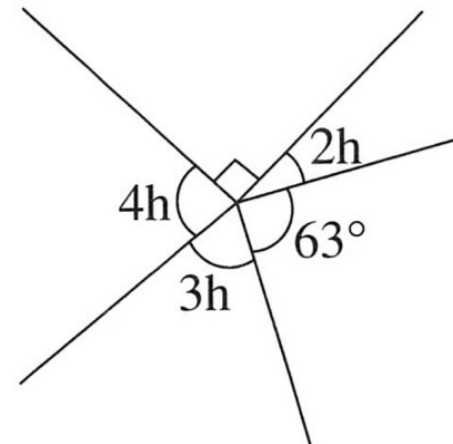
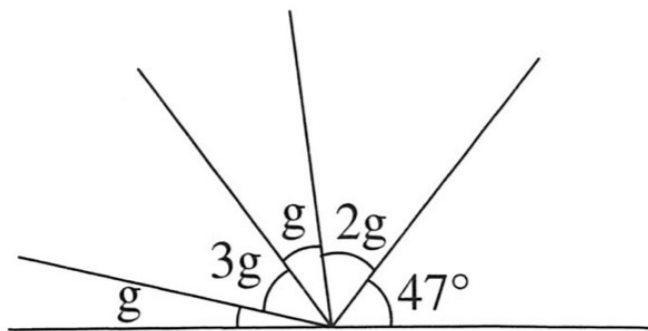
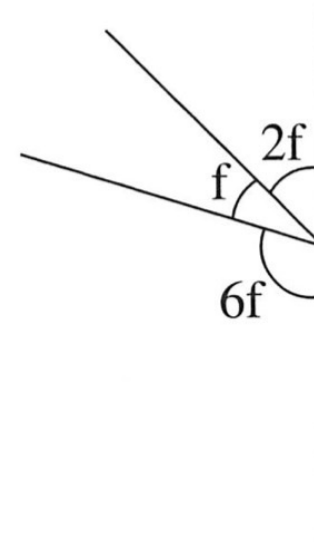
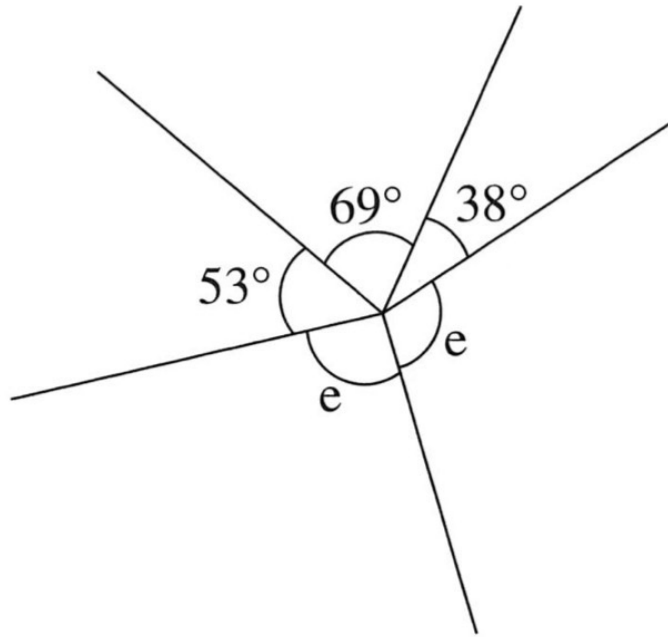

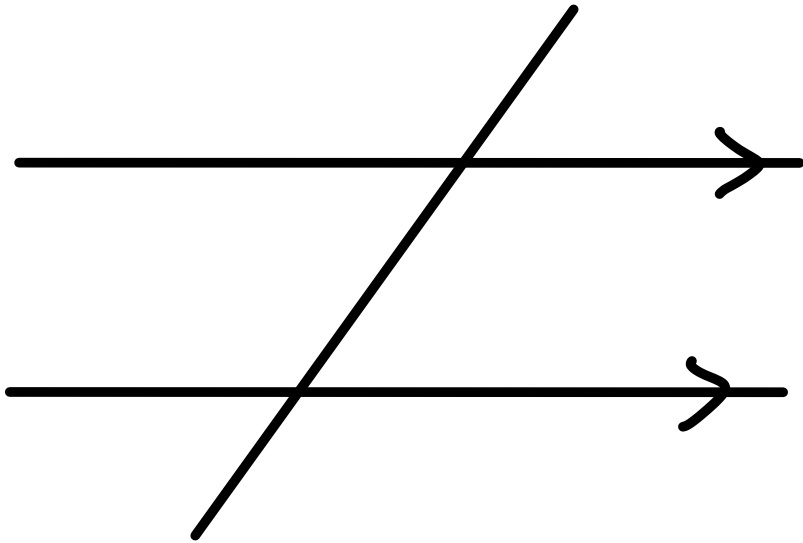

1. Corresponding angles are equal

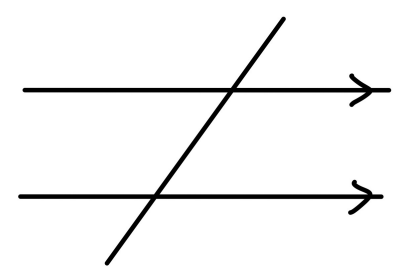
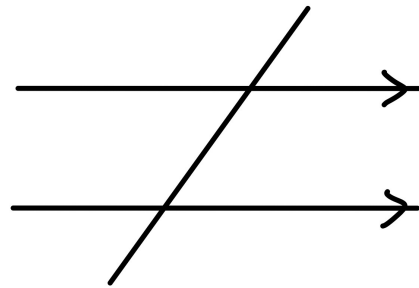
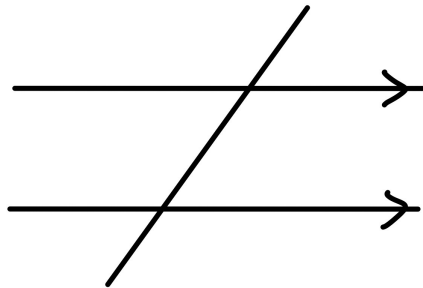
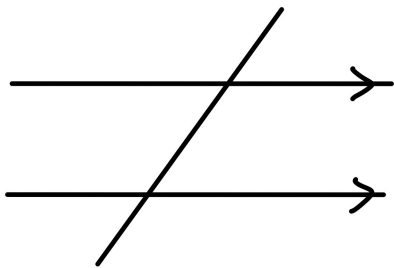

## 2. Alternate angles are equal

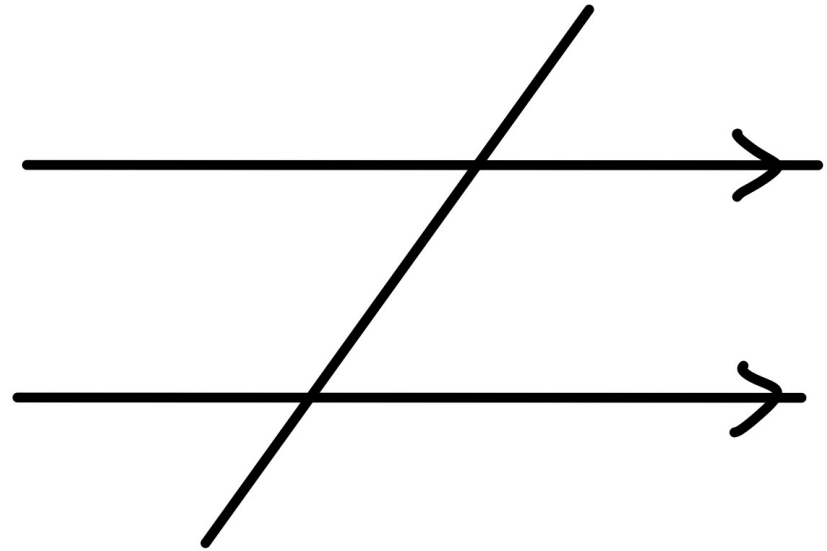
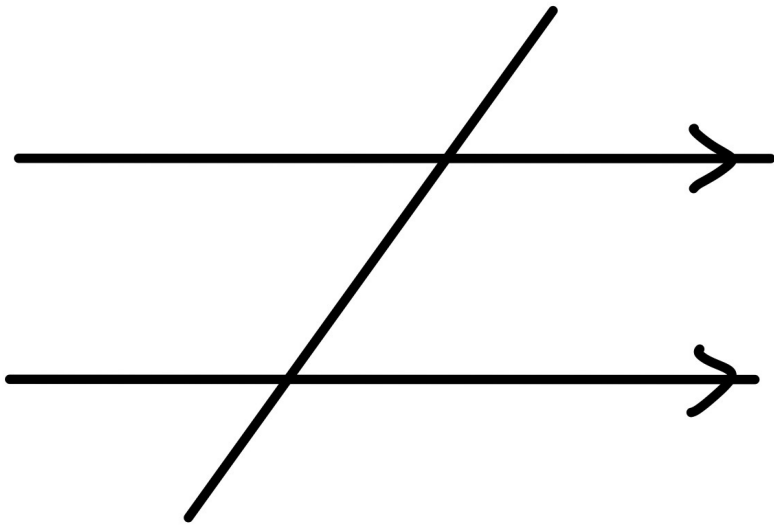

### 3. Co-interior angles add up to 180 degree ( allied angles)

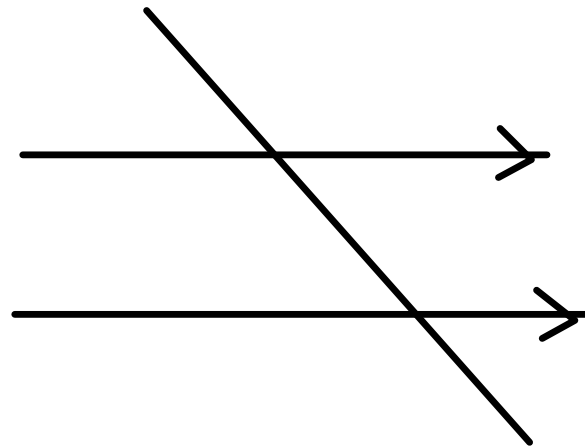
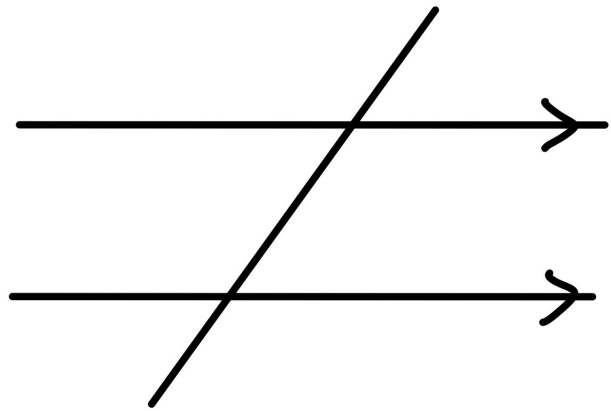

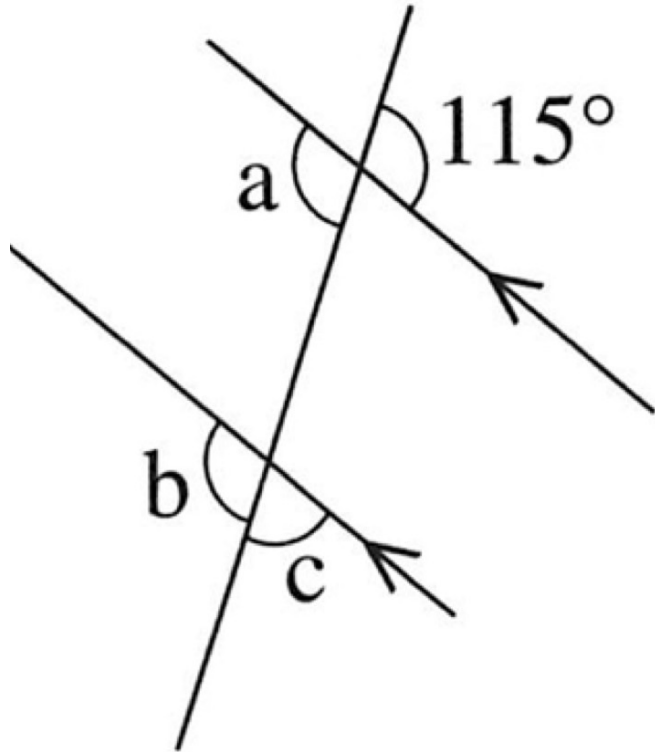

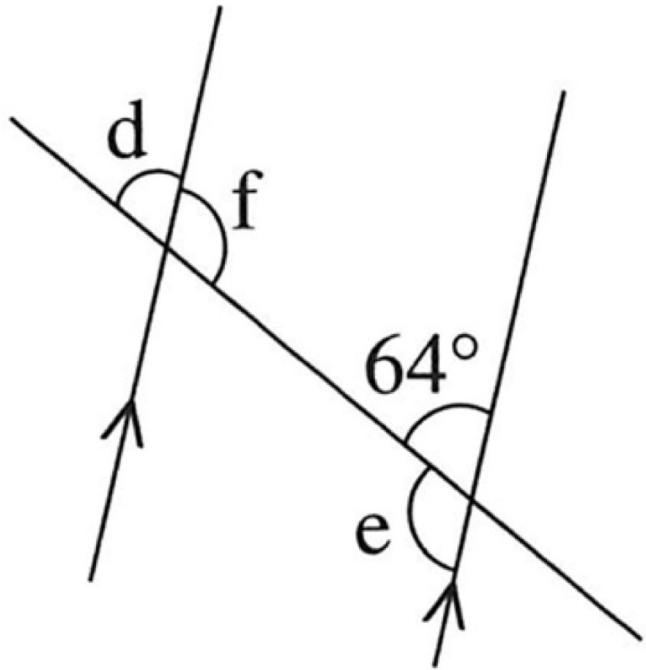

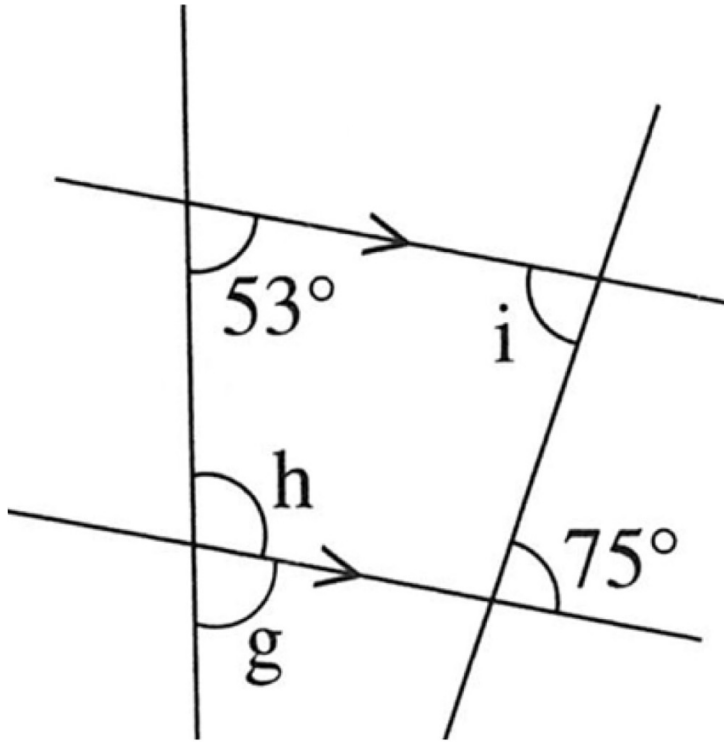

Find the angles marked with letters.

**NOW you can do it !**

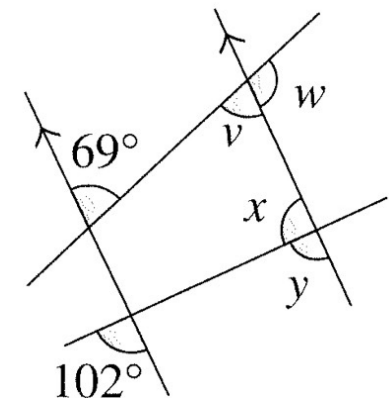
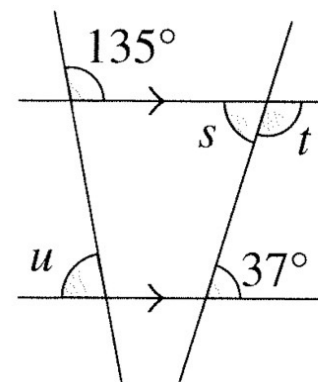
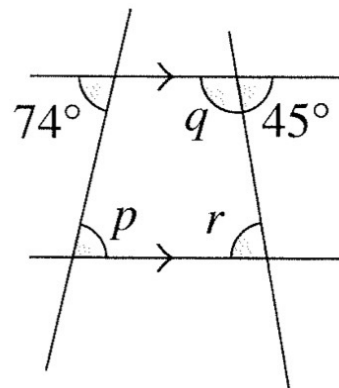
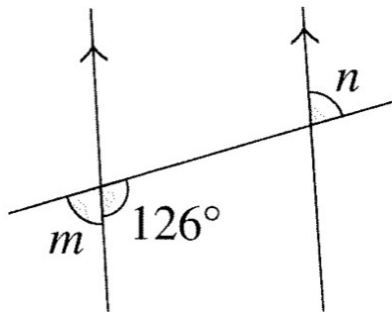
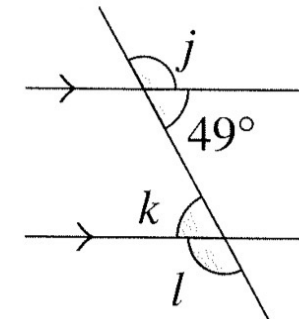
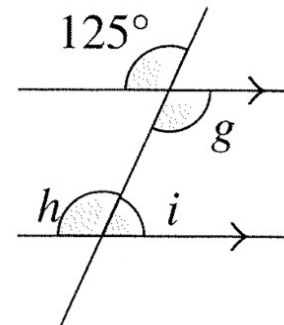
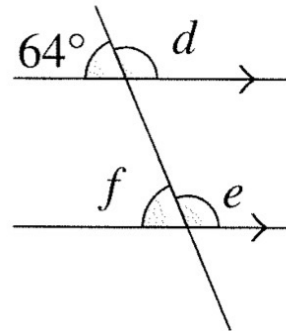
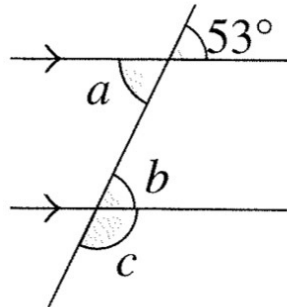

## Names of polygons

3 sides = Triangle

4 sides = Quadrilateral

5 sides = Pentagon

6 sides = Hexagon

7 sides = Heptagon

8 sides = Octagon

9 sides = Nonagon

10 sides = Decagon

11 sides = Undecagon

12 sides = Dodecagon

# Regular vs Irregular polygons

## Regular polygons



Equilateral Triangle

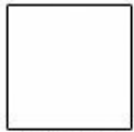

Square



Regular Pentagon

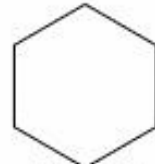

Regular Hexagon



Regular Heptagon



Regular Octagon



Regular Nonagon



Regular Decagon

## Irregular polygons

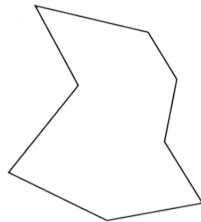
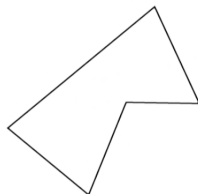
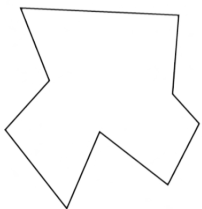

# Triangles

Why sum of angles is 180 degree ???

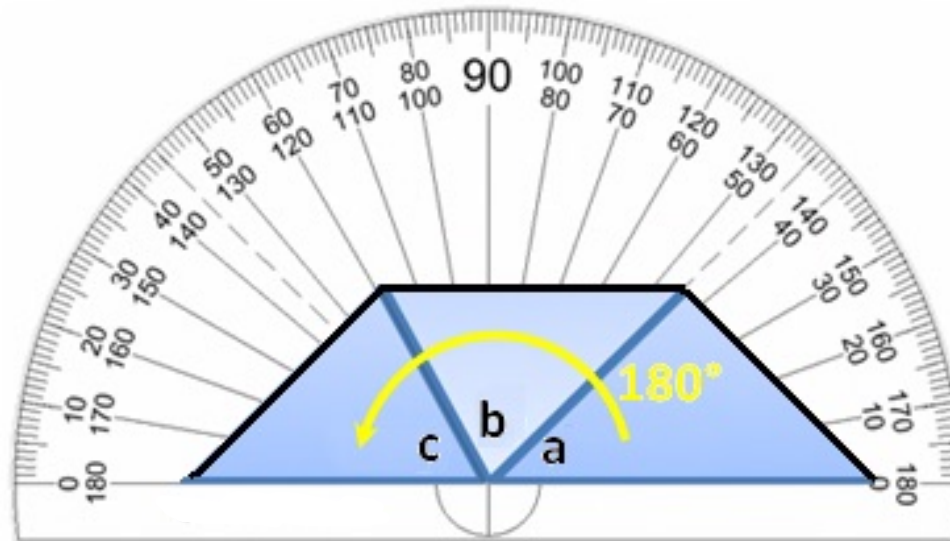
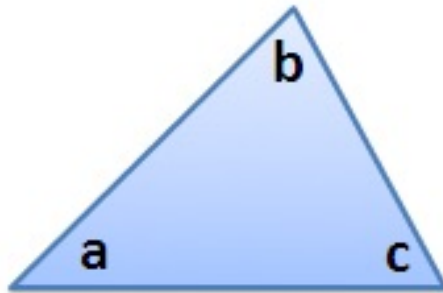

# Triangles

**\*Sum of angles is 180 degree\***

Scalene triangles

Equilateral triangles

Isosceles triangles

# Try to do !

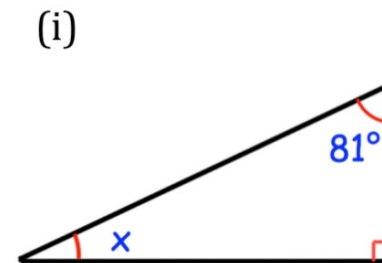
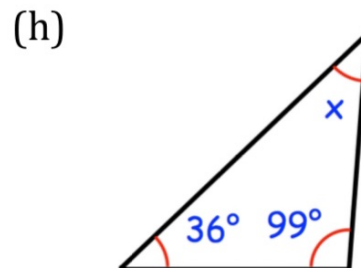
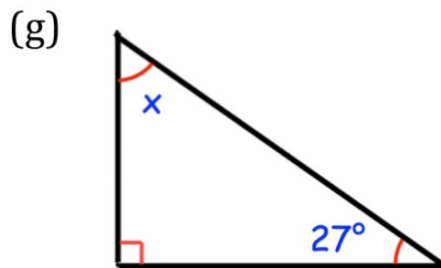
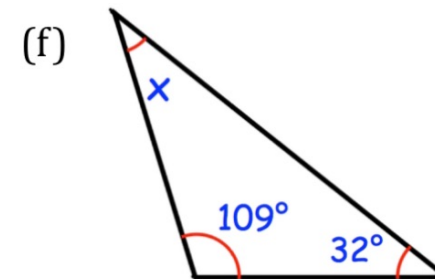
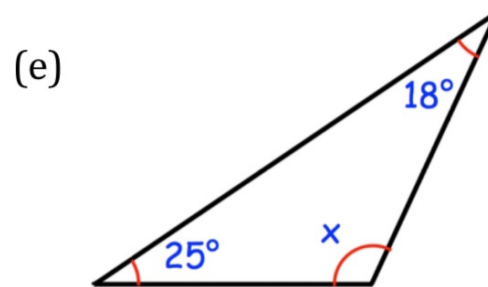
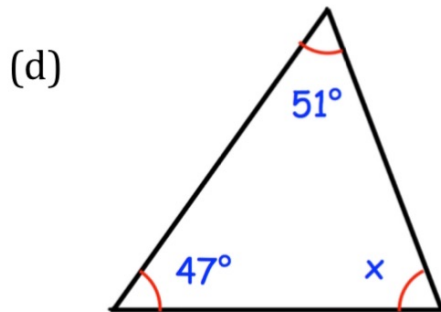
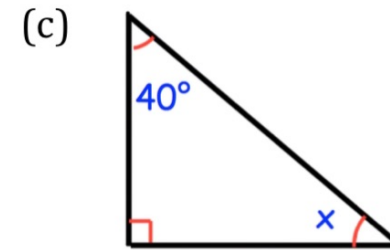
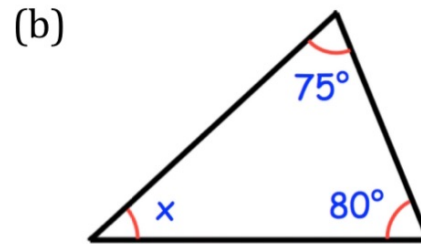
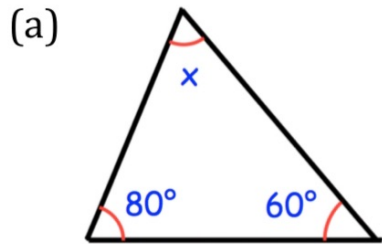



(a)

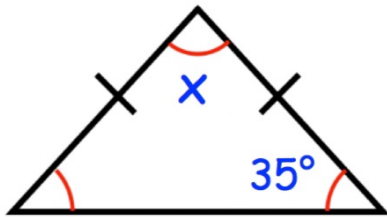

(b)

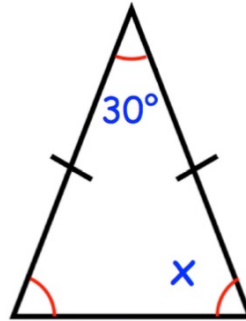

(c)

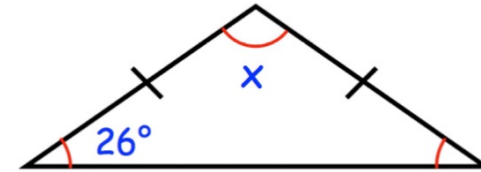

(d)

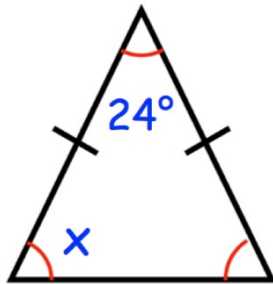

(e)

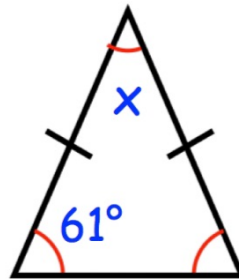

(f)

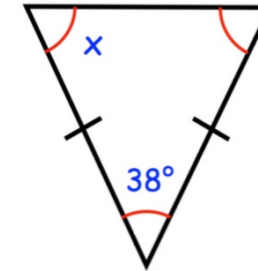

 **Special note** 



You can do it !

(a)

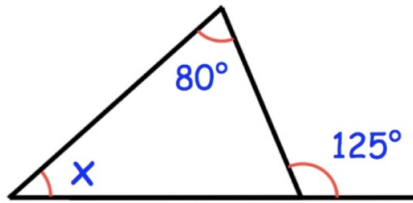

(b)

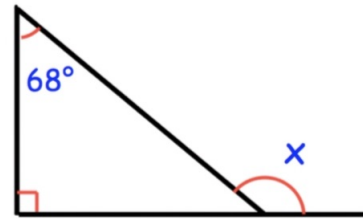

(c)

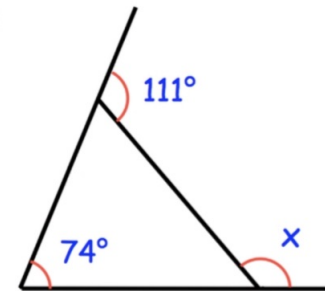

(d)

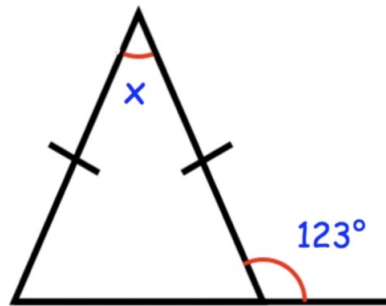

(e)

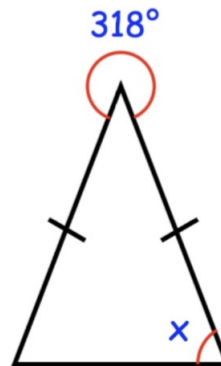

(f)

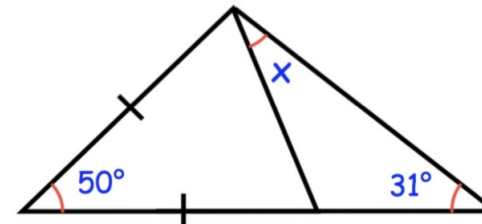

(g)

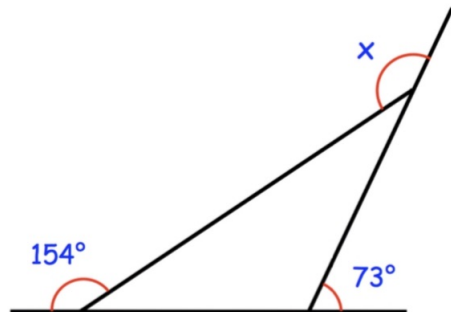

(h)

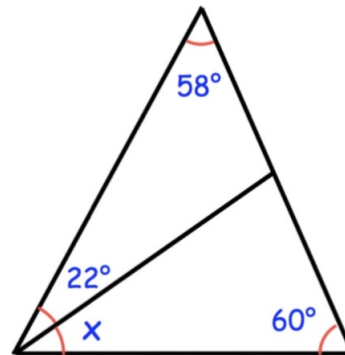

(i)

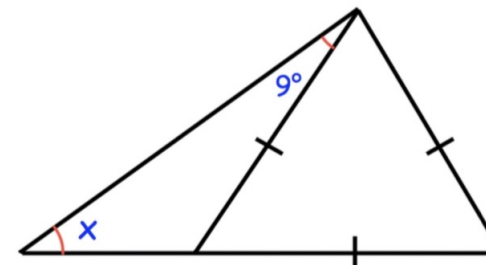

# Quadrilaterals

**\*Sum of angles is 360\***



Irregular  
Quadrilatera

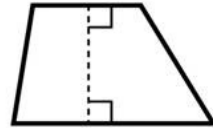

Trapezium

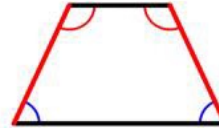

Isosceles  
Trapezium

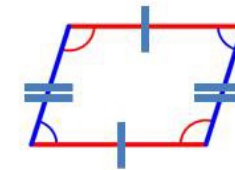

Parallelogram

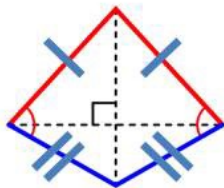

Kite

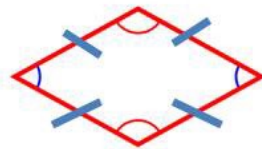

Rhombus

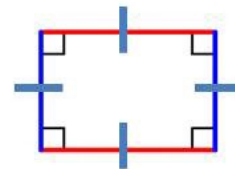

Rectangle

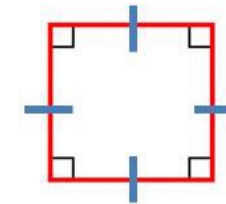

Square

# Quadrilaterals

**\*Sum of angles is 360\***

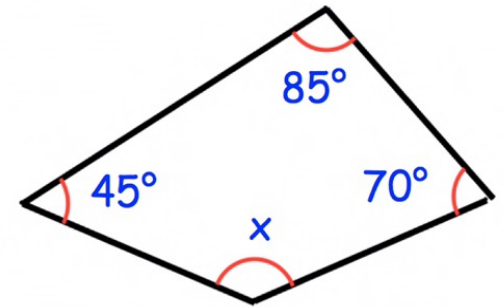
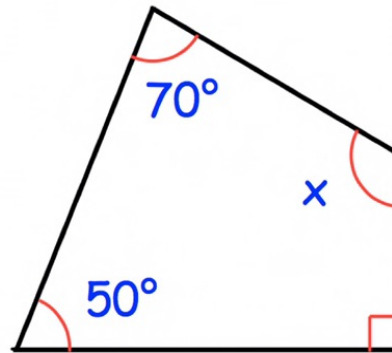
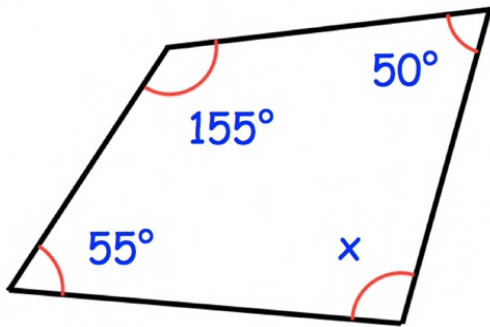

# Quadrilaterals

**\*Sum of angles is 360\***

## Parallelogram

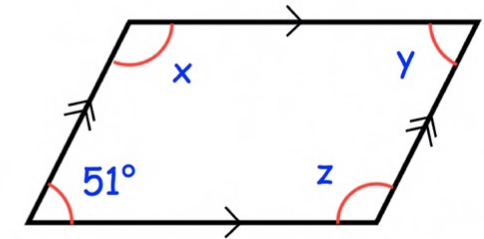
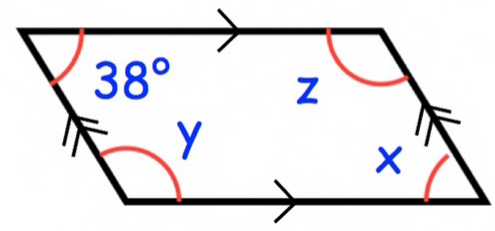
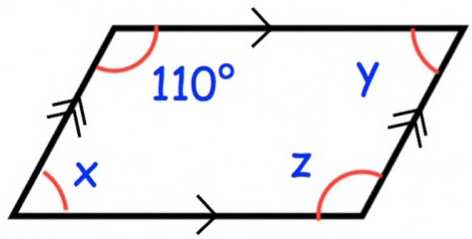

# Quadrilaterals

**\*Sum of angles is 360\***

## Rhombus

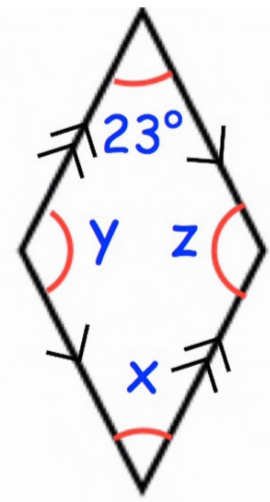
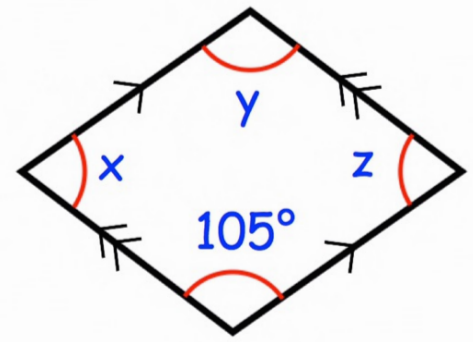
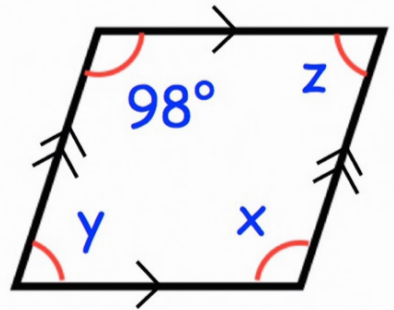

# Quadrilaterals

**\*Sum of angles is 360\***

## Kite

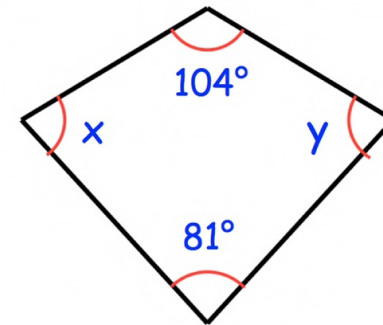
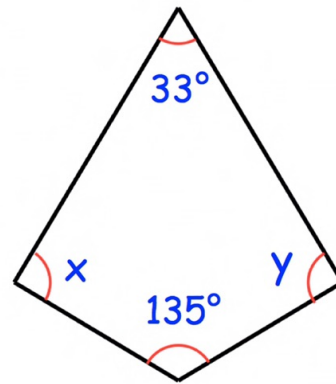
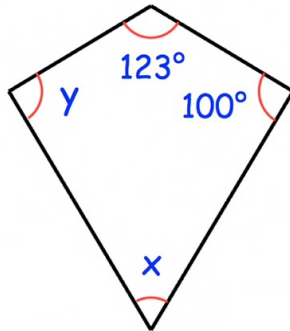

# Quadrilaterals

**\*Sum of angles is 360\***

## Trapezium

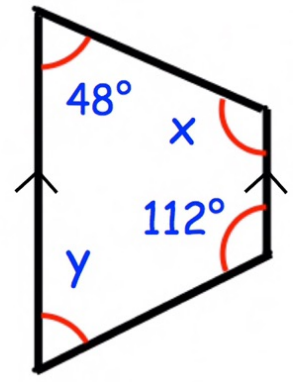
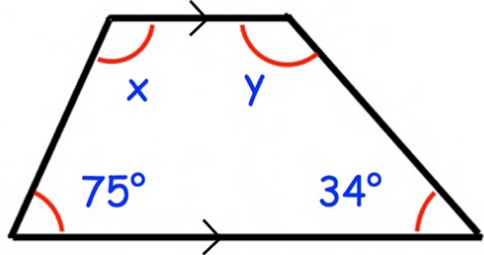
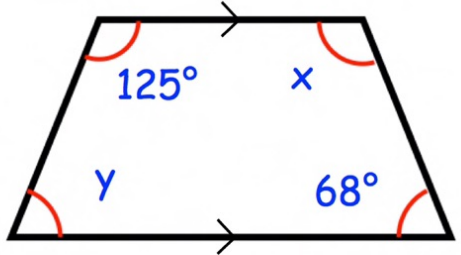



....Practice makes PERFECT....

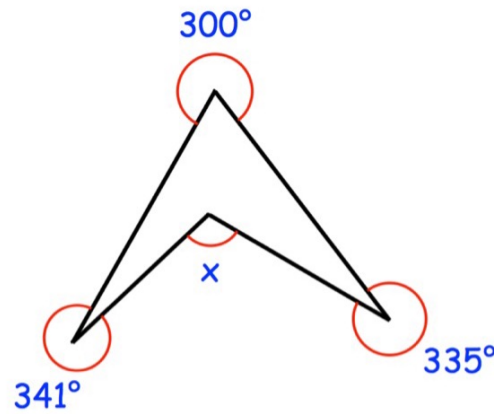
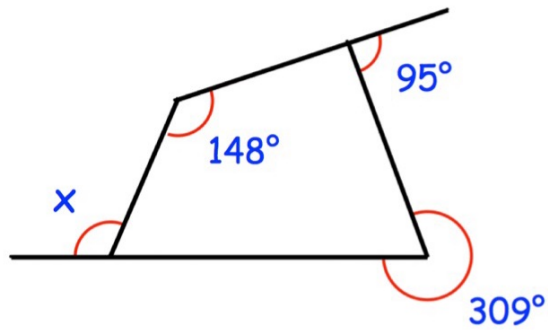
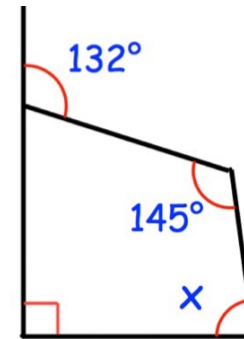
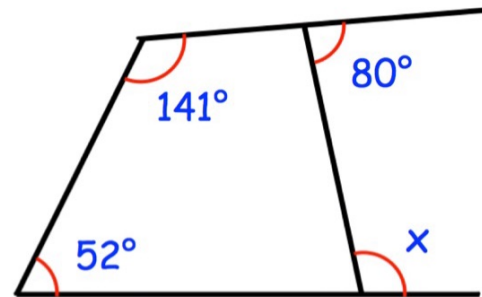
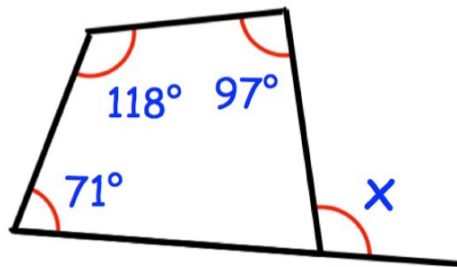

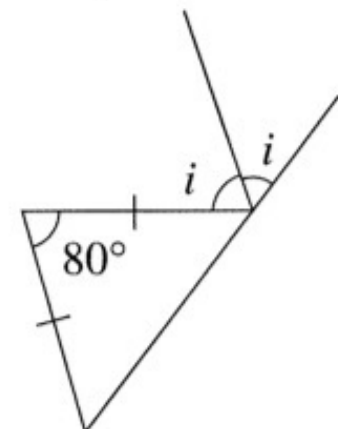
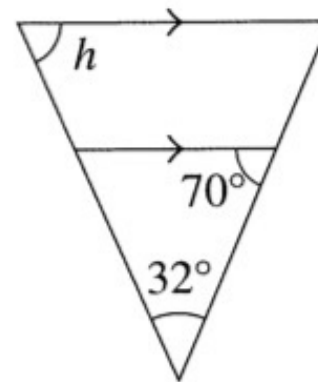
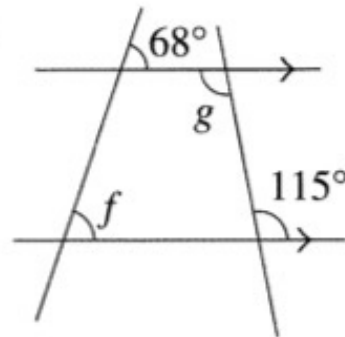
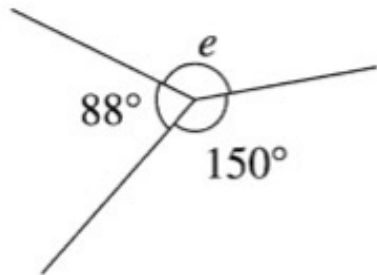
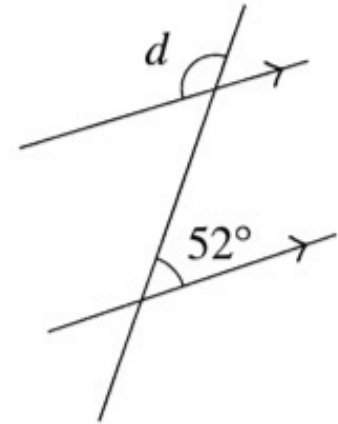
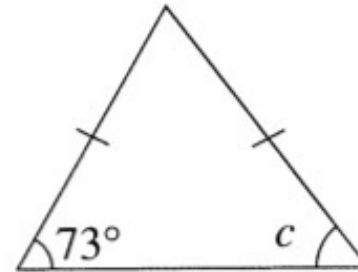
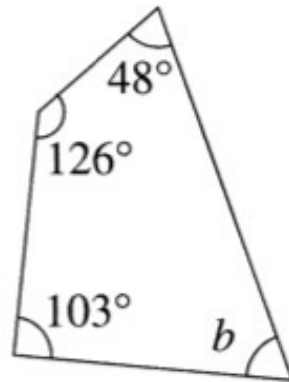
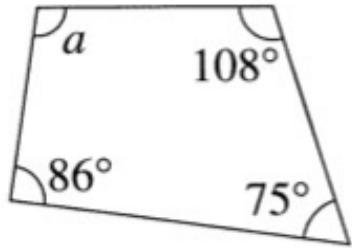

# Angles : Exercise

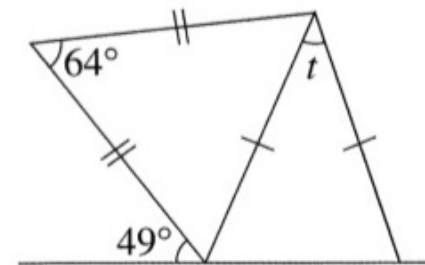
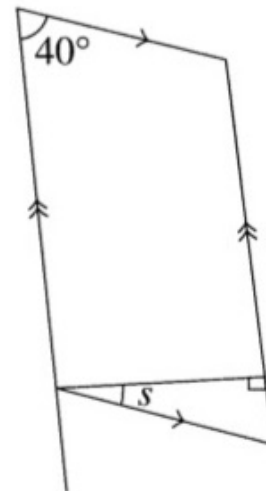
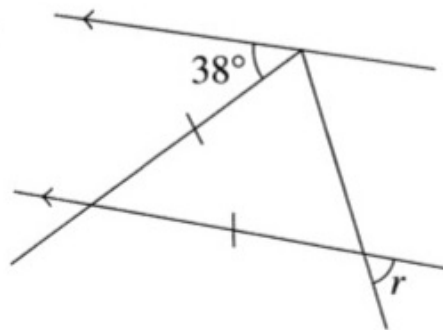
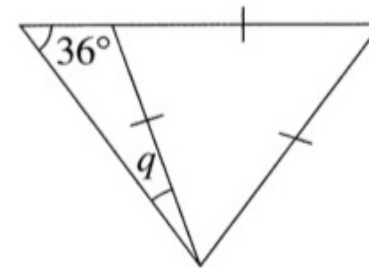
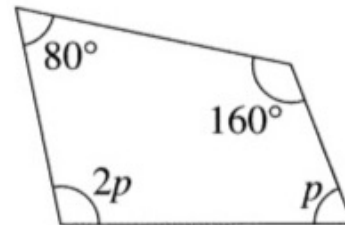
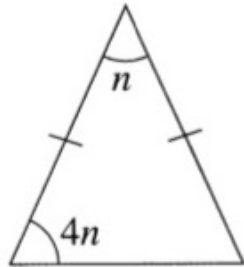
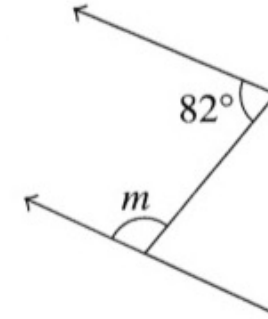
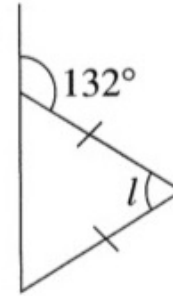
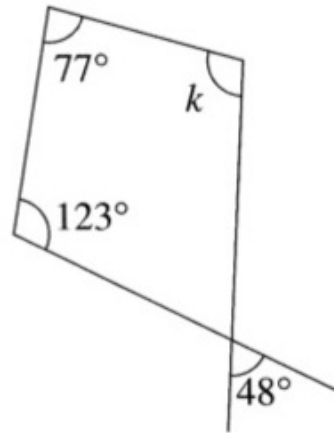
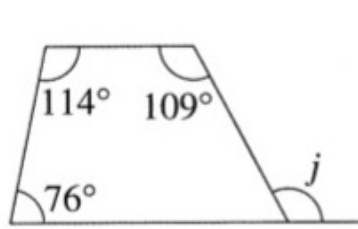

Any polygon

# Interior angles and exterior angles

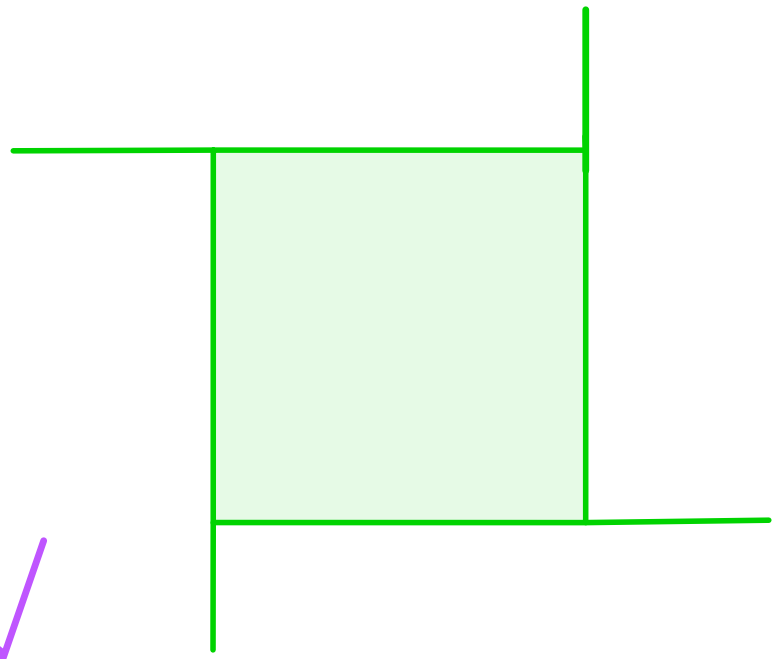
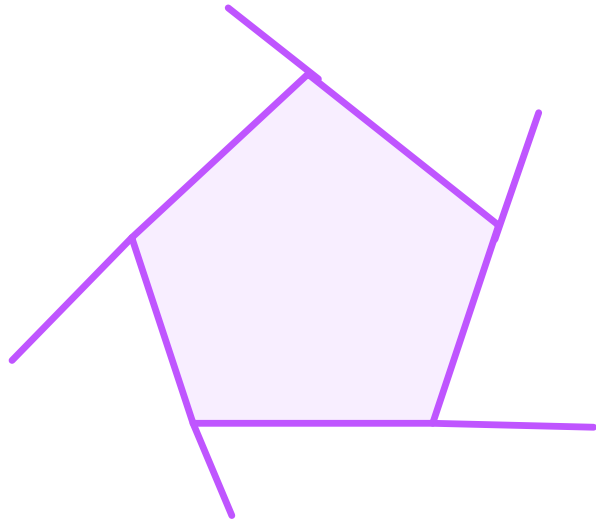
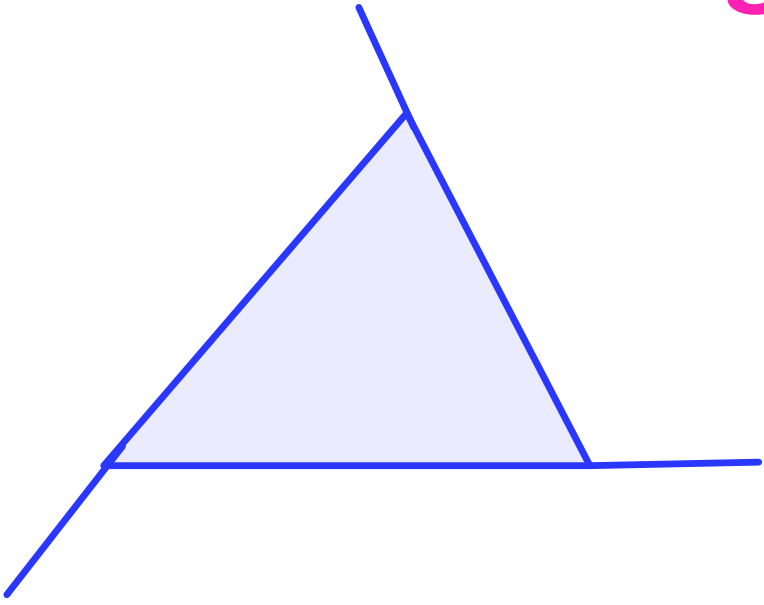

# Sum of interior angles

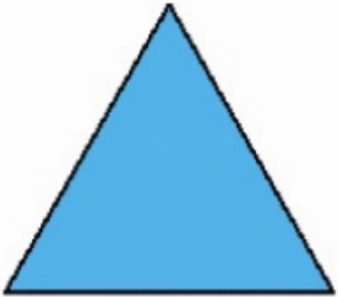

Triangle

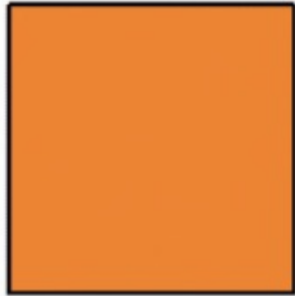

Quadrilateral

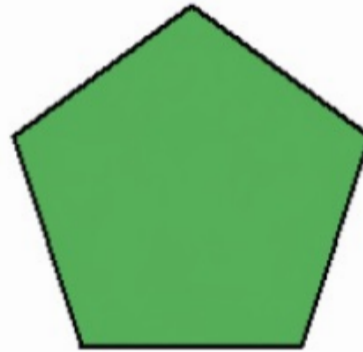

Pentagon

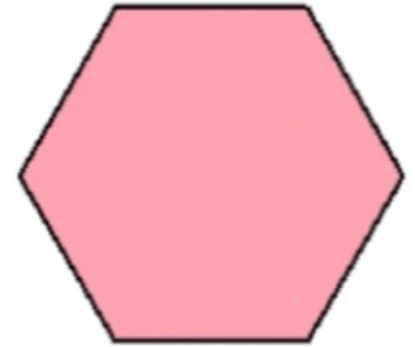

Hexagon



When  $n$  is number of sides in Polygon

$$\text{Sum of interior angles} = 180 \times (n-2)$$

For regular polygon , you can find each interior angle

Because each angle is equal



$$\text{One interior angle} = \frac{180 \times (n-2)}{n}$$

# Find missing angles

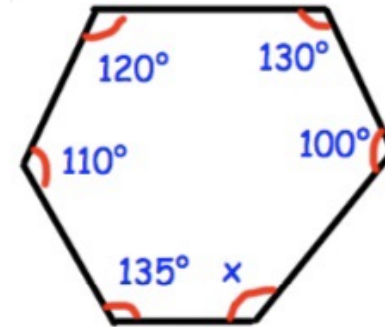
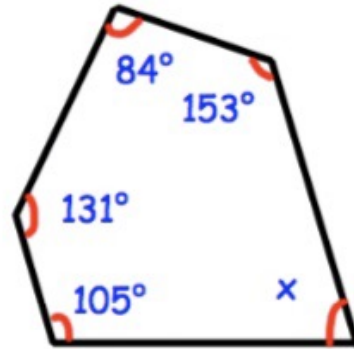
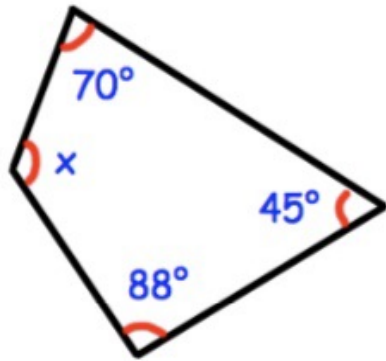

# Find missing angles



regular pentagon

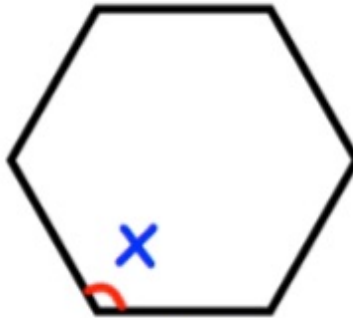

regular hexagon

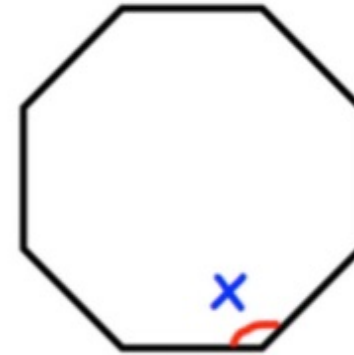

regular octagon

# Sum of exterior angles

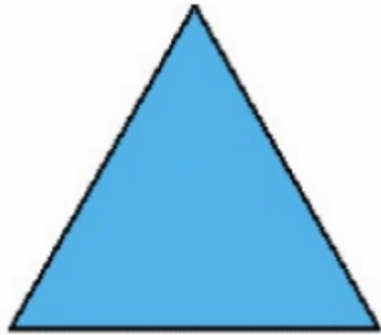

Triangle

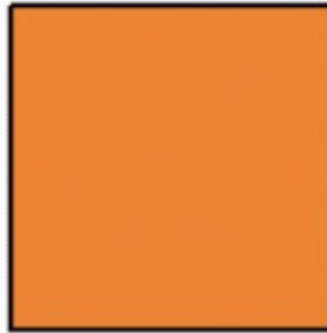

Quadrilateral

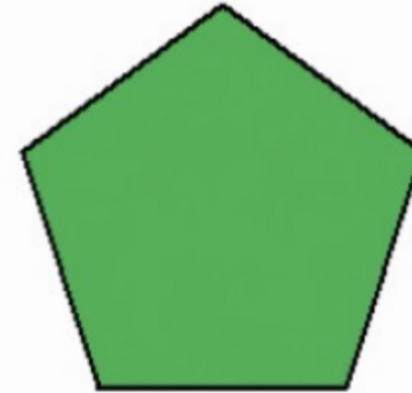

Pentagon



Sum of exterior angles in any polygon  
is always **360** degree



For regular polygons

$$\text{One exterior angle} = \frac{360}{n}$$

# Find missing angles

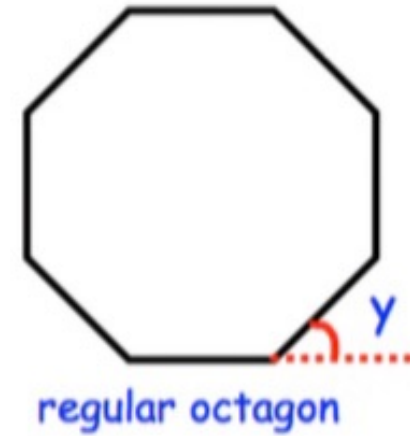
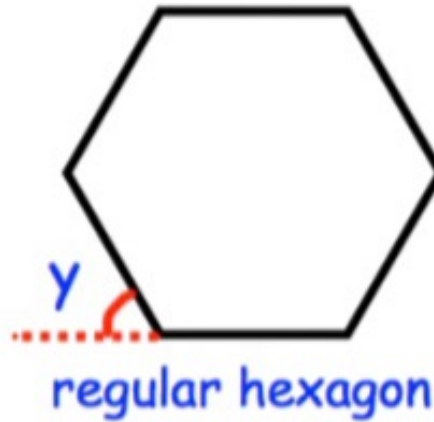

Find the number of sides of regular polygon,  
when interior angle is given



Find the number of sides of regular polygon,  
when interior angle is given



Find the number of sides of regular polygon,  
when exterior angle is given



## Find missing angles

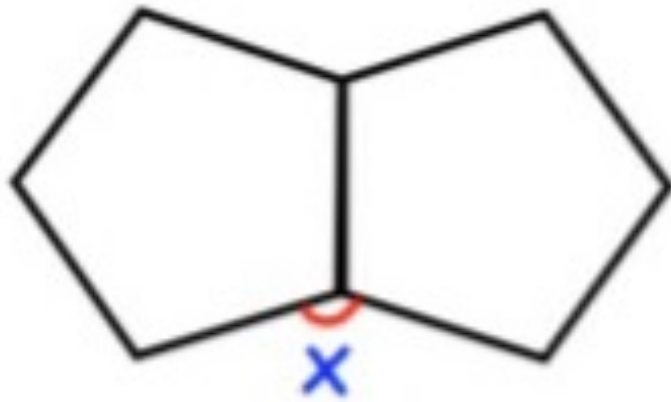

# Find missing angles

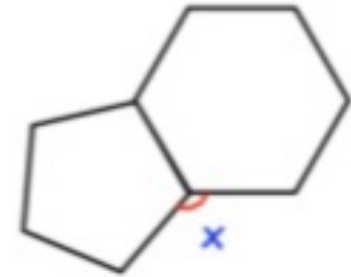
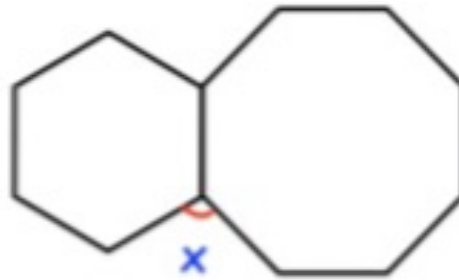
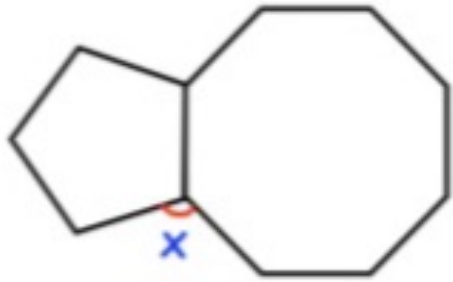



The diagram shows a pattern using four identical rhombuses.

Diagram **NOT**  
accurately drawn

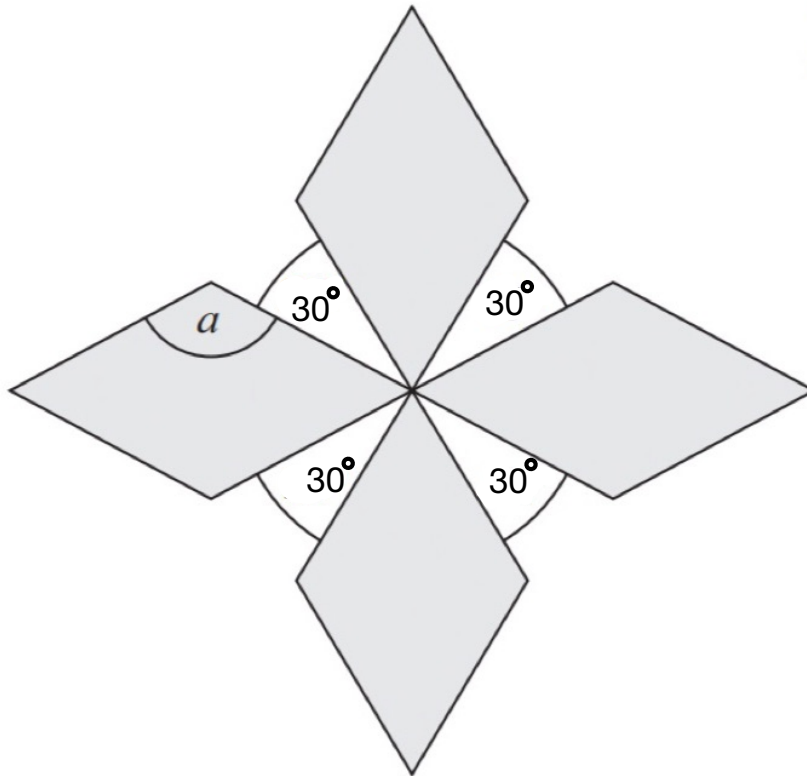

Work out the size of the angle marked  $a$ .  
You must show your working.

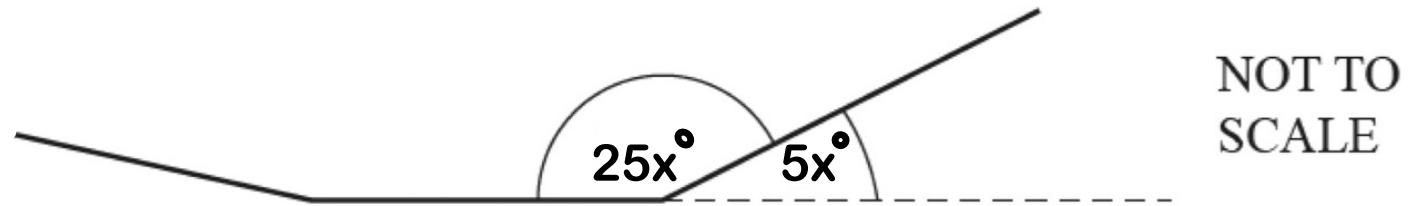

The diagram shows part of a regular polygon.

The exterior angle is  $25x^\circ$

The interior angle is  $x^\circ$

Work out the number of sides of this polygon.

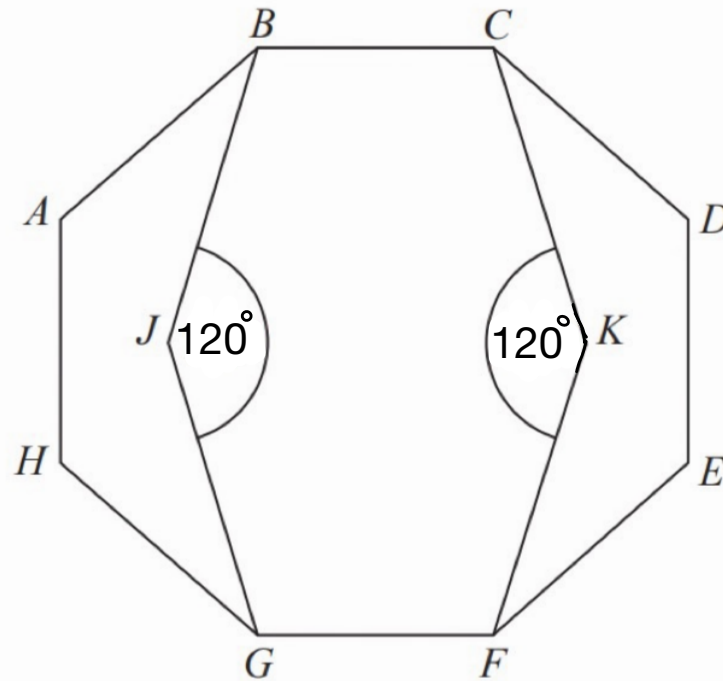

Diagram **NOT**  
accurately drawn

$ABCDEFGH$  is a regular octagon.  
 $BCKFGJ$  is a hexagon.

$JK$  is a line of symmetry of the hexagon.  
Angle  $BJG = \text{angle } CKF = 120^\circ$

Work out the size of angle  $KFE$ .  
You must show all your working.